

ARCAM ^{FMJ}

Integrated Amplifier

Power Amplifier

DAVE Amplifier

MARC Amplifier

ARCAM

PEMBROKE AVENUE, DENNY INDUSTRIAL CENTRE, WATERBEACH, CAMBRIDGE CB5 9PB, ENGLAND

TELEPHONE: 44+(0) 1223 203203 FAX: 44+ (0) 1223 863384 e-mail: support@arcam.co.uk www.arcam.co.uk

Thank you for choosing ARCAM

FOUR MODELS

This Handbook covers 4 different models, as follows:

An integrated amplifier

A power amplifier

The DAVE (Digital Audio Video Entertainment) amplifier

The MARC (Multi Area Remote Control) amplifier

IMPORTANT NOTES

SAFETY

There are 19 safety items, set out on page 25 of this Handbook. For your own safety, and to ensure that your amplifier works properly, we strongly recommend that you read them.

SOUND CUTS OUT FOR NO APPARENT REASON

If the temperature of the internal heatsinks rises above a safe level, then a thermal cut out inside the amplifier will operate. The POWER INDICATOR on the front panel will turn orange and the protection system will temporarily remove the power to the speakers. The system will reset itself as the heatsinks cool down.

When playing a heavily recorded CD it is possible to drive the A22 at full power despite the fact that the volume is not at maximum. This is because of the high output voltage from a CD player.

AMPLIFIER DOESN'T SWITCH BACK ON

All amplifiers have a 'protection mechanism' which will be activated if you switch the unit on again immediately after turning it off. The mechanism may stop it being turned back on. If the mechanism activates, wait 30 seconds, then try again.

CONTENTS

For ease of use, this handbook has been divided into 4 sections.

Integrated amplifier

Power amplifier

DAVE (Digital Audio Video Entertainment) amplifier

MARC (Multi Area Remote Control) amplifier

Each of the sections has a short introduction to the product, followed by an 'User Guide' which is primarily for users who have had their system installed by their dealer or supplier. Following the 'User Guide' is a section describing 'Advanced Features' (depending on the complexity of the product). Finally for customers wishing to set up their own system, a section called 'Setting Up'.

Integrated amplifier

User Guide	4
Using the Remote Control Handset	5
Advanced features	6
Setting up	7-8
Bi-wiring your speakers	9
Bi-amping	10

Power amplifier

User Guide	11
Setting up	12
Integrated and Power amplifiers - Technical Specifications	13

DAVE amplifier (HOME THEATRE MODULE)

User Guide	14
Setting up	15-19
Advanced features	20
Remote Control Handset	21

MARC amplifier (MULTI AREA MODULE)

User Guide	22-23
Advanced Features	24

Safety Guidelines	25
Guarantee	26

Integrated amplifier - User Guide

Circled numbers in the text, e.g. 7, refer to the numbers on the pictures. If your integrated amplifier HAS NOT been installed for you, you should read the section entitled 'Setting up' before using the 'User Guide'.

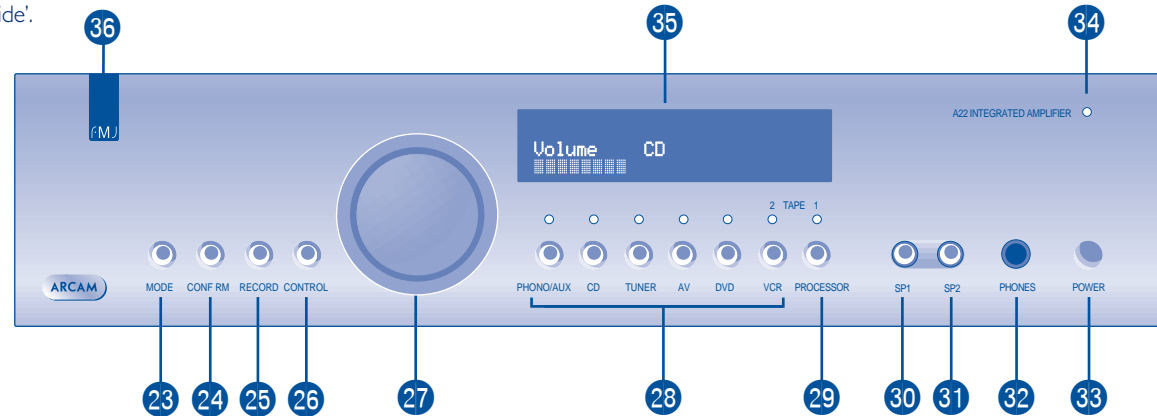

INTRODUCTION

A microprocessor is at the heart of the amplifier. It performs several important functions. It switches the amplifier on or off from standby mode and mutes the two sets of speakers individually as well as the pre-amp output. It is also responsible for the remote bus and infra red remote input. Parameters can be selected, and displayed, on the built in graphic display enabling easy set up of the amplifier and simple source selection. In addition, the amplifier uses LED markers to indicate the primary source which is in use. In addition to a full suite of audio line level inputs, there is also a high quality optional MM/MC phono stage. To protect your amplifier, the microprocessor monitors the heatsink temperature and RF content of the speaker outputs. In the event of the amplifier being over driven, it can activate the automatic speaker protection circuits and it can report fault conditions to the main display.

IN USE

- 33 POWER**
Switches the unit on and off. The unit can also be switched into 'standby' by use of the remote control handset.
- 34 POWER INDICATOR**
This will initially glow amber. After a few seconds, it will glow green. When the indicator glows amber, the speakers are disconnected and an internal protection circuit is activated. The power indicator will turn red if the unit has been put into standby mode by use of the remote control. Under certain conditions the power indicator may flash and a fault condition will be shown on the display 35. If this happens you should unplug the mains lead of the unit and leave the unit for a few minutes before re-connecting. If the fault condition persists unplug and contact your Arcam dealer.
- 30 SPI**
Selects or de-selects the main (upper) pair of speakers. Push the button in to select.
- 31 SP2**
Selects or de-selects the secondary (lower) pair of speakers. Push the button in to select. Important note: If both switches are turned off the amplifier will appear not to work, as all speakers will be switched off!

- 27 VOLUME**
Adjusts the volume level of the loudspeakers, pre-amp out and headphones. The volume can also be controlled with the Remote Control Handset. As the volume knob is not motorized the knob will not move when adjusted remotely. If you spin the knob quickly it will not change the volume. This is to prevent accidentally setting the volume too high.

NOTE ON VOLUME CONTROL SETTINGS

It is important to realise that the position of the volume control is not an accurate indication of the power delivered to your loudspeakers. The amplifier will often deliver its full power long before the volume control reaches its maximum position particularly when listening to heavily recorded compact discs. However the amplifier also has to be capable of giving full power output from much lower level sources, such as tuners and cassette decks. Using these sources, the volume control setting may be much higher before distortion (audible overload) sets in.

- BALANCE**
Press CONTROL 26, turn the volume knob to the desired balance, then press CONTROL again to fix the balance you have selected.

- 26 CONTROL**
This button cycles (or steps) through the functions that can be controlled by the volume knob. This can be either volume (the default setting) or balance. If you have a DAVE or MARC, there are several other functions. Refer to those sections of this handbook.

- 28 ENTERTAINMENT (SOURCE) SELECTORS**
These buttons select the source (i.e. Radio (TUNER), Compact Disc (CD) etc.) you wish to listen to.

- 36 REMOTE RECEIVER**
The remote receiver is behind the FMJ badge. Make sure the remote receiver is not covered or signals from the Remote Control Handset will not be received.

- 32 HEADPHONES SOCKET**
Accepts headphones rated between 8 ohms and 2k ohms fitted with a 1/4" stereo jack plug. If you wish to listen on headphones only, use SPI and SP2 (if necessary) to mute the speakers. The headphone socket is always active.

Integrated amp - Using the Remote Control

If you have an integrated amplifier or MARC amplifier, you will have a Remote Control similar to the one shown below.

This CR-389 Remote Control gives access to all functions available on the front panel of FMJ amplifiers. It also has controls to operate Arcam CD players, AM/FM tuners and DAB tuners.

The Remote Control transmits Philips RC-5 type codes.

DAVE REMOTE CONTROL

If you have a DAVE amplifier, you will have the the CR9000 Remote Control as shown in the DAVE amplifier section of this handbook. That Remote Control allows you to operate the integrated amplifier plus some basic functions of an Arcam or Philips based CD player or Tuner.

TUNER

These buttons are used to control tuner functions. Note that the FM/DAB lights indicate into which mode you are switching the remote control. The lights only illuminate for five seconds to conserve battery power. If neither light is illuminated this does not mean that the remote control is not working!

OTHER AMPLIFIER FUNCTIONS

Note that greyed-out buttons on the remote control diagram are of use with other Arcam amplifiers.

SOURCE SELECTION BUTTONS

These operate in the same way as the source selectors on the front panel of your integrated amplifier.

Don't forget to fit the two AAA batteries supplied and ensure they are inserted correctly into the back of the remote control before using it.

The Remote Control sends a message to an infrared receiver which is located behind the FMJ badge on the front of the amplifier. Do not place anything in front of the badge or the Remote Control may not work.



POWER/STANDBY

Toggles the amplifier between standby mode and full power mode. The power indicator light next to the power button on the front panel is red if the amplifier is in standby, amber while the amplifier is powering up (this only takes a few seconds) and green when the amplifier is powered up.

SPI AND SP2

These buttons allow you to select and deselect the main (SPI) and secondary (SP2) sets of speakers attached to your amplifier (see page 4).

DISP

Cycles through the settings 'Bright', 'Off' and 'Dim'. Turning the display 'Off' generally gives a slight improvement in sound quality.

VOLUME AND MUTE

Press '+' to increase volume or '-' to decrease the output volume of the amplifier. Press 'MUTE' to mute the speaker connections and preamp outputs. Both tape outputs and the headphone socket remain active. Mute is disabled either by pressing 'MUTE' again, or by adjusting the volume.

CD CONTROLS

These offer basic controls of Arcam CD players, such as the FMJ CD23.

Integrated amp - Advanced features

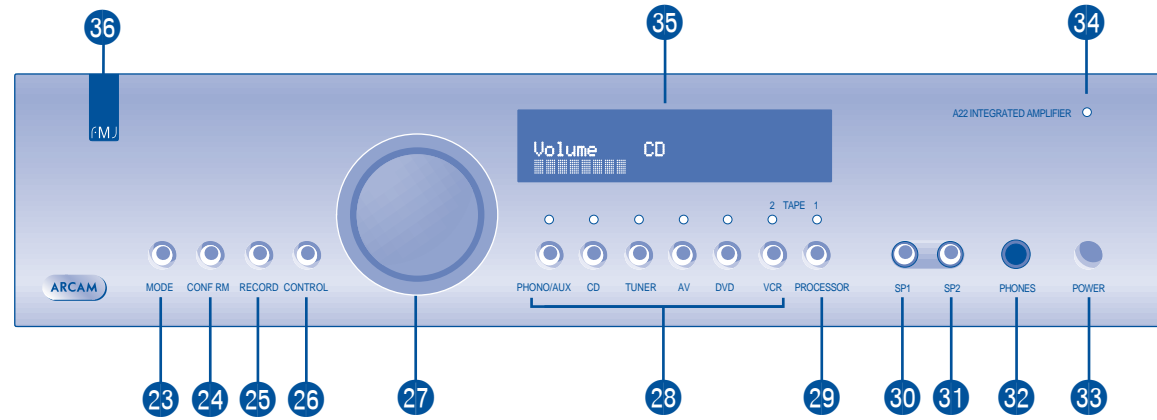

IN USE

25 TAPE RECORDING

Note: The integrated amplifier must be fully powered up in order to record. Both sets of tape sockets are identical in sensitivity and suitable for use with almost any type of recorder (cassette, hi-fi VCR, reel to reel, DAT, etc.) The entertainment source selected (i.e. Radio (TUNER), Compact Disc (CD) etc. will automatically be the signal you record (and is sent to both the VCR and PROCESSOR RECORD output sockets) unless you select another source. To select another source, press RECORD. The display will first show 'RECORD SOURCE'. Select an alternative input by pressing the appropriate button, (i.e. Radio (TUNER), Compact Disc (CD) etc. Your selected choice will show in the display. The display will indicate the selected recording option for a few seconds and then revert back to showing the volume bar graph. Press 'RECORD' twice to go back to 'RECORD SOURCE'. If you are using the TAPE 1 sockets in processor mode. The signal selected will not go to both the VCR and PROCESSOR RECORD output sockets but go to the VCR/TAPE 2 instead. This RECORD button can also be used as a 'second zone' selector; sending (a source signal at line level) to a second amplifier operating in another room in the house.

TAPE TO TAPE COPYING (DUBBING)

The integrated amplifier allows two way tape dubbing from TAPE 2 to TAPE 1 but NOT TAPE 1 to TAPE 2. For example, to copy from a cassette recorder connected to the VCR/TAPE 2 sockets to a cassette recorder connected to TAPE 1, first use the RECORD selector 25 on the integrated amplifier to select 'RECORD :VCR'. This routes the TAPE 2 signal to TAPE 1's output. Then set the tape recorder connected to TAPE 1 sockets into its 'record' mode and the other to 'playback' mode to enable the transfer to take place. If you wish to monitor the transfer while it is taking place select TAPE using the TAPE1/PROCESSOR button 29.

23, 24

MODE & CONFIRM

These buttons are only for use with optional modules such as the DAVE or MARC amplifiers. They have no function on their own in normal use on the basic integrated amplifier although MODE can be used to select processor mode, as described below.

29 PROCESSOR/TAPE 1

This is tape loop to monitor a recording made on a 3 head cassette deck. It can also be used to connect to an external surround decoder such as the Arcam Xeta 2. Selecting this input overrides the other source selectors 28. To play back or to monitor the recording from a cassette deck attached to the PROCESSOR/TAPE 1 input press the processor button 29. 'TAPE' is shown on the display. For use with an external processor the A22 can be put into processor mode by first selecting PROC and then whilst holding in the MODE button 23 press the PROC button 29 again. The display will now show 'PRO' in place of 'TAPE'. If the processor you are using is an Arcam Xeta 2 then press the PROC button again while holding in the MODE button so that 'PRO2' is displayed.

The volume level of the integrated amplifier will now be fixed so that you can use the volume control of the external processor as a master volume control. Using the volume or mute buttons on the remote handset or the front panel control knob will have no effect whilst in processor mode. The unit will return to processor mode whenever 29 is pressed.

Once in 'PRO2' mode the AV, TAPE 1, VCR and DVD buttons on the CR235 remote control will have no effect. This is because the Xeta 2 will also respond to these Remote Control codes and switch to the wrong input. If you want to change the input back for use as a normal tape input hold the MODE button in and press the PROCESSOR button until 'TAPE' appears on the display.

CAUTION: Do not set the integrated amplifier in processor mode if you have a cassette deck or other line level source attached to the PROCESSOR/TAPE 1 input. This is because selecting processor mode input will send a fixed volume signal straight into the power amplifier which could damage your loudspeakers.

NOTE: If you are using the integrated amplifier with an external processor, via the PROCESSOR/TAPE 1 loop you must set the volume of the integrated amplifier so that you can see at least one segment of the volume level bar graph before switching to the PROCESSOR input. If you fail to do this you will not hear any sound from the speakers attached to the integrated amplifier. To obtain a sound again, reselect another input eg CD and turn the volume up slightly. Then reselect the PROCESSOR input.

Integrated amp - Setting up

CONNECTING TO A POWER SUPPLY

CAUTION

Your amplifier generates heat in use. It is therefore most important to ensure adequate ventilation and not to obstruct the ventilation slots on the top of the unit as this could cause overheating.

WRONG PLUG !

If the plug supplied with the amplifier does not fit your power supply, see the section entitled 'Safety Guidelines' for changing a plug, or contact your dealer to obtain a suitable power cord.

Check that your mains supply voltage agrees with the voltage setting indicated on the rear panel of the amplifier at 1.

If your mains supply voltage is different, consult your Arcam dealer or Arcam Customer Support on 01223 203203.

PLUGGING IN

Push the plug (IEC line socket) of the cable supplied with the amplifier, into the socket 2 (POWER INLET) in the back of the amplifier. Make sure it is pushed in firmly. Push the plug on other end of the cable into your power supply socket.

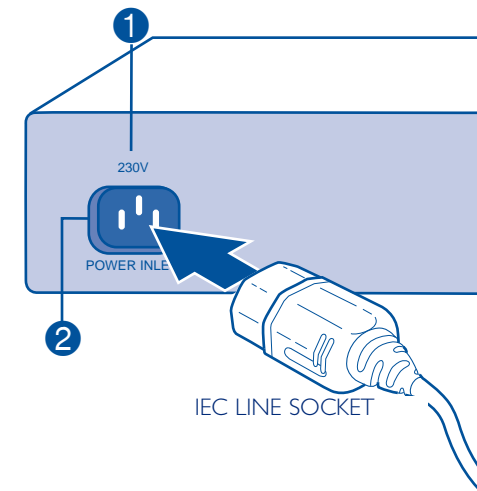

CONNECTING TO LOUDSPEAKERS

Your amplifier is fitted with loudspeaker terminals, to BFA, (British Federation of Audio) standard specification.

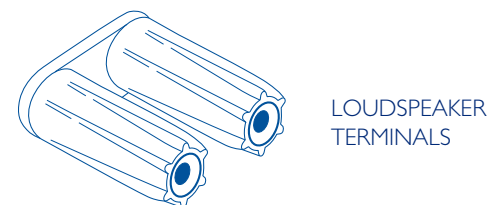

The terminal will accept spade terminals, bare wires or a BFA plug. BFA plugs are available from your Arcam dealer. To connect a bare wire or spade terminal unscrew the red (or black) part of the loudspeaker terminal first. Insert the wire or spade terminal and screw it back up.

CAUTION

Do not over tighten the loudspeaker terminals or use a wrench, pliers, etc., as this could cause damage to the terminals which will not be covered under warranty.

Connect the right hand speaker to the terminals on the back of your amplifier marked R and the left speaker to the terminals marked L.

Connect your loudspeakers so that the red (positive/+) terminal on each loudspeaker is connected to the red (positive/+) terminal on the amplifier. Your loudspeaker cables may be marked to show polarity (negative/- and positive/+), if not, then the positive terminal can usually be identified by a ridge or coloured marking.

Now connect your loudspeaker's black (negative/-) terminals to the black (negative/-) terminal on the amplifier.

Ensure that no stray strands of inner wires are allowed to touch another cable or the amplifier's casing. This can cause a short circuit and damage your amplifier! Two pairs of speakers may be connected at the same time provided each pair is rated between 8 and 16 ohms. If one or both pairs have an impedance of less than 8 ohms, the combined load 'seen' by the amplifier will fall below 4 ohms and could cause an overload. The overload protection circuit will engage and the amplifier will not work.

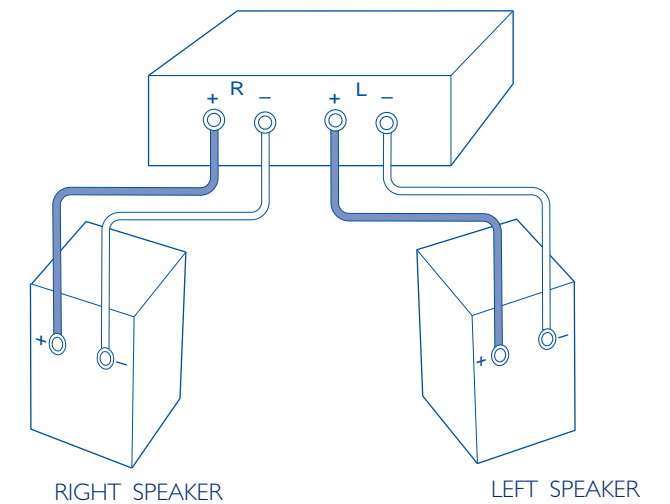

Integrated amp - Setting up Continued

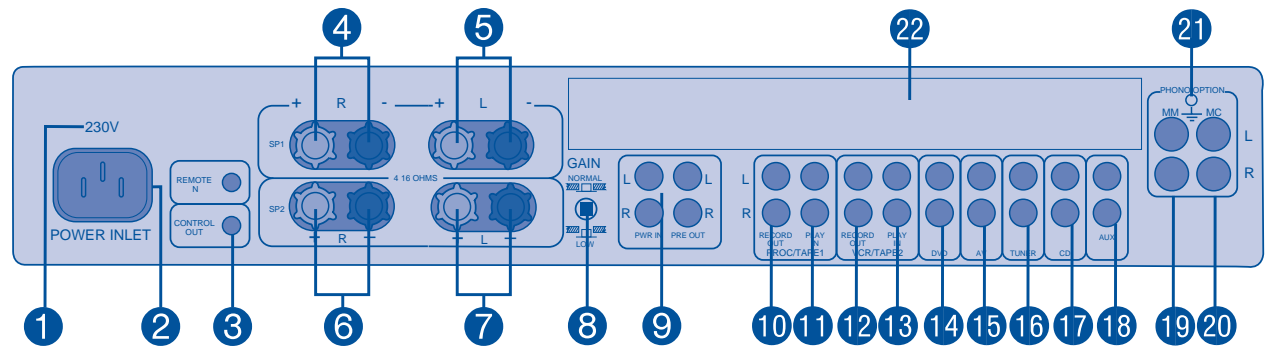

CONNECTING TO OTHER EQUIPMENT

The use of high quality interconnect cables to and from your integrated amplifier is recommended to ensure the best sound quality (sonic performance). The sockets carrying messages from your integrated amplifier are marked L (left) and R (right), for identification. Sockets marked L on your integrated amplifier should be connected to sockets marked L on other equipment. All the line inputs (not PHONO) have the same sensitivity and may be used with equipment other than that labelled, if you need to do so.

- 10 PROCESSOR/TAPE 1 RECORD OUT**
Connect this output to the input sockets of your tape deck (RECORD) or the tape or line input sockets of your AV processor.
- 11 PROCESSOR/TAPE 1 PLAY IN**
Connect this input to the output sockets of your tape deck (PLAY) or the tape or line output sockets of your AV processor.
- 12 VCR/TAPE 2 RECORD OUT**
Connect this output to the input sockets of your tape deck (RECORD).
- 13 VCR/TAPE 2 PLAY IN**
Connect this input to the output sockets of your tape deck (PLAY).
- 14 DVD**
Connect this input to the audio outputs of a DVD player.
- 15 AV**
Connect this input to the audio outputs of an Audio-Visual product such as a VCR, Laserdisc player or Nicam tuner.
- 16 TUNER**
Connect this input to the audio outputs of your radio tuner.
- 17 CD**
Connect this input to the audio outputs of your CD player or DAC (digital to analogue convertor).
- 18 AUX**
Connect this input to the audio outputs of any unit with a line level output, eg. tape deck, tuner etc. Please note: The AUX inputs MUST NOT be used if the phono module is fitted. When the phono module is fitted AUX becomes an output carrying the equalised phono signal at line level.

PHONO OPTION - Please note: The phono inputs are on a separate plug-in module which your Arcam dealer or distributor can supply and fit. This module is compatible with most high output moving coil and moving magnet cartridges (MM) and low output moving coil cartridges (MC). MM or MC is selected via an internal switch. Your cartridge type should be specified when the module is fitted.

- 19 MM**
For connecting a turntable fitted with a high output moving coil or a moving magnet (MM) cartridge.
- 20 MC**
For connecting a turntable fitted with a low output moving coil (MC) cartridge.
- 21 GROUND TERMINAL**
For connecting your turntable earth lead (if fitted).
- 3 REMOTE CONNECTION**
These connections are for use in multi-room installations. In normal use there is no need to make any connections to these sockets. If you are biamping with an Arcam power amplifier see section 'Remote Switching' for details of how to power both units on/off simultaneously.
- 8 GAIN**
This switch allows you to change the sensitivity of the amplifier to match the gain when biamping to external power amp. The normal position is suitable for use when biamping with Arcam power amplifiers. The low gain position is suitable for certain specialist home theatre systems. Before making any connections ensure that all equipment is switched off at the mains wall socket.
- 9 PRE/POWER CONNECTIONS**
PWR AMP IN - To use your integrated amplifier just as a power amplifier, connect the output of your pre-amplifier to the PWR AMP IN sockets. The integrated amplifier's internal selector switch must be changed to disconnect the pre-amp stages of the unit. Contact your dealer or Arcam for more details. Under these circumstances it has exactly the same specification and performance as an Arcam power amplifier.
PRE-AMP OUT - To use your integrated amplifier as a preamplifier, connect the PRE-AMP OUT sockets to the input sockets of your power amplifier. With a power amplifier of the correct gain (e.g. An Arcam P25) this allows you to bi-amplify ('bi-amp') suitable loudspeakers, giving significant improvements in sound quality (see section on BI-WIRING/ BI-AMPING).

Bi-wiring your speakers

Bi-wiring improves the sound of your system because it divides the high and low frequency signal currents into separate speaker cables. This avoids signal distortions arising from the high and low frequency currents interacting with one another within a single cable, as in conventionally wired systems.

YOU WILL NEED
Speakers which have four terminals (connection points for wires) on the back of each one. That's eight in total. If you have four terminals on each speaker they will be marked HF (High frequency) and LF (Low Frequency).
Loudspeaker cables
Two pairs of loudspeaker cables per loudspeaker (which may be joined at the amplifier end if your amplifier only has one pair of output terminals per channel). Or, a suitably terminated cable set (group of bound cables, probably prepared by your dealer) capable of being used for bi-wiring in one length.

WARNING
Do not make any connections to your amplifier while it is switched on or connected to the mains supply. Please check all connections thoroughly, make sure bare wires or cables are not touching the amplifier in the wrong places (shorts) and you have connected positive (+) to positive (+) and negative (-) to negative (-) before attempting to re-connect the mains power supply. Always ensure that the volume control on your amplifier is set to a minimum before switching on.

HOW TO BI-WIRE LOUDSPEAKERS

1. Remove the wire clips or bars which connect the pairs of terminals together (terminal links) on each of the red and black terminals on the rear of your loudspeakers.
- THIS IS ESSENTIAL OR DAMAGE TO YOUR AMPLIFIERS MAY RESULT WHICH IS NOT COVERED UNDER WARRANTY.
2. Connect the cables as shown in one of the pictures opposite, dependant on the cables and the number of free amplifier terminals you have, ensuring correct polarity at all times. The positive (+) terminals on the right loudspeaker must go to the positive (+) terminals on the right of the amplifier and the negative (-) terminals on the right loudspeaker must go to the negative (-) terminals on the right of the amplifier etc.

SHOWN BELOW IS THE BI-WIRING CONFIGURATION USING ONE SET OF SPEAKER CONNECTIONS ON THE INTEGRATED AMPLIFIER.

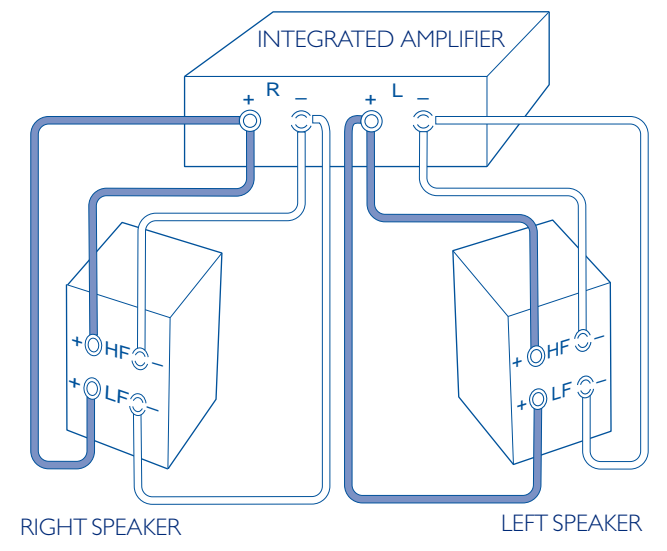

If you are using one pair of bi-wireable speakers and another pair that is not, you should connect your bi-wireable speakers as shown above, to just one set of the amplifier terminals. This leaves the second set of terminals to connect the non bi-wireable speakers to.

SHOWN BELOW IS THE BI-WIRING CONFIGURATION USING BOTH SETS OF SPEAKER CONNECTIONS ON THE INTEGRATED AMPLIFIER.

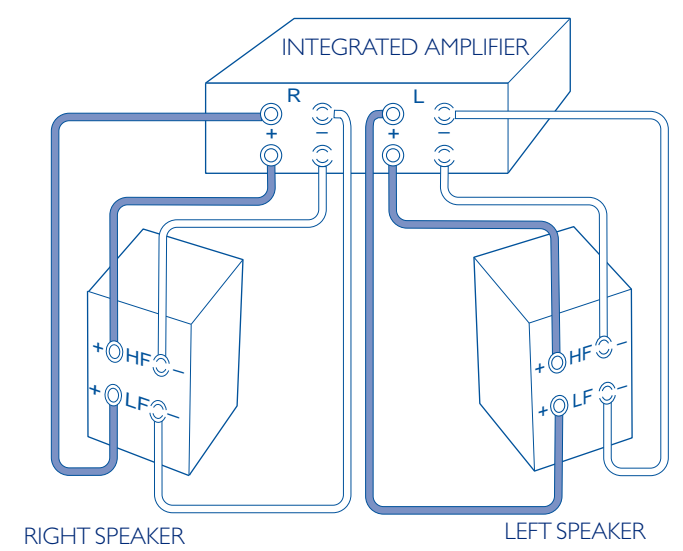

Bi-amping

The performance of your system can be further enhanced over that achieved with bi-wiring, by extending the same principal one stage further to include separate amplification for the low and high frequency speaker drive units in each loudspeaker box.

YOU WILL NEED

Speakers which have four terminals (connection points for wires) on the back of each one. That's eight in total. If you have four terminals on each speaker they will be marked HF (High frequency) and LF (Low Frequency).

Two stereo amplifiers

Generally, one of these would be an Arcam integrated amplifier and the other an Arcam power amplifier.

Loudspeaker cables

Two pairs of loudspeaker cables per loudspeaker or a suitably terminated cable set (group of bound cables, probably prepared by your dealer) capable of being used for bi-amping in one length.

Interconnect cables

One pair of high quality interconnect cables.

If one of your amplifiers is an integrated amplifier it is best to use that one connected to the high frequency (HF) speaker terminals (and their respective drive units) whilst the power amplifier (out-board amplifier) is used to drive the low frequency (LF) speaker terminals (and their respective drive units).

WARNING

Do not make any connections to your amplifier while it is switched on or connected to the mains supply. Please check all connections thoroughly, make sure bare wires or cables are not touching the amplifier in the wrong places (shorts) and you have connected positive (+) to positive (+) and negative (-) to negative (-) before attempting to re-connect the mains power supply. Always ensure that the volume control on your amplifier is set to a minimum before switching on.

HOW TO SET UP A BI-AMPED SYSTEM

1. Remove the wire clips or bars which connect the pairs of terminals together (terminal links) on each of the red and black terminals on the rear of your loudspeakers.

THIS IS ESSENTIAL OR DAMAGE TO YOUR AMPLIFIERS MAY RESULT WHICH IS NOT COVERED UNDER WARRANTY.

2. Connect the cables as per one of the diagram opposite, ensuring correct polarity at all times. The positive (+) terminals on the right loudspeaker must go to the positive (+) terminals on the right of the amplifier and the negative (-) terminals on the right loudspeaker must go to the negative (-) terminals on the right of the amplifier etc. You also need to make a connection from the PRE AMP OUT sockets of your integrated amplifier, or preamplifier, to the POWER AMP IN sockets of the power amp.

3. Use the interconnect cables to connect the PRE-AMP OUT sockets 9 of the integrated amplifier to the PWRAMP IN sockets of the power amplifier.

Always switch on the integrated amplifier and allow it to stabilise (indicator light turns green) before switching on the power amplifier. At the end of a listening session the power amplifier should always be turned off first.

High quality interconnect cables should be used between the integrated amplifier and power amplifier.

The use of high quality interconnect and speaker cables in your system is essential to obtain good sound quality. Contact your dealer for further details.

SHOWN BELOW IS THE BI-AMPING CONFIGURATION RECOMMENDED FOR THE ALPHA AMPLIFIERS COVERED IN THIS HANDBOOK

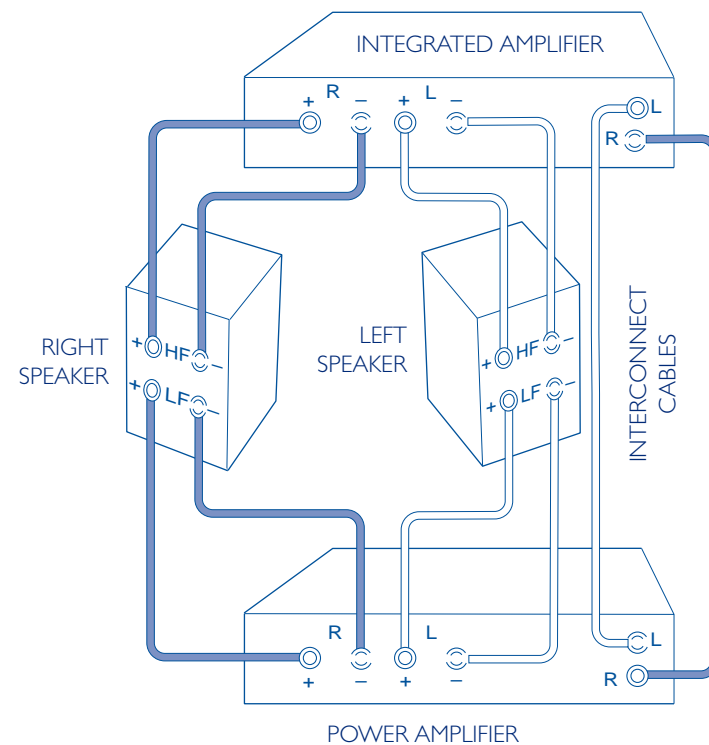

Power amplifier - User Guide



INTRODUCTION

The power amplifier shares all of the electronic and structural advantages of its sister integrated amplifier.

It can also be upgraded from stereo mode to three channel audio by the addition of a 'PAM' (Power Amp Module). This module offers extra terminal connectors together with a third set of pre-out and power-in phono sockets to turn the power amplifier into a 3 x 100 watts (RMS per channel into 8 Ohms) amplifier suitable for Home Cinema or Karaoke use. Contact your dealer for further details.

IN USE

Circled numbers in the text, e.g. 33, refer to the numbers on the pictures.

If your power amplifier has not been installed for you, you should read the section entitled 'Setting up' before using the 'User Guide'.

33 POWER

Switches the power on and off.

34 POWER INDICATOR

This will initially glow orange. After a few seconds, it will glow green. When the indicator glows orange, the speakers are disconnected and an internal protection circuit is activated.

30 SPI

Push the button in to select the main (upper) pair of speakers. Push the button in to select.

31 SP2

Selects or de-selects the secondary (lower) pair of speakers. Push the button in to select.

The SPI & SP2 switches will both connect/disconnect speakers attached to the 3rd channel option 12 if fitted.

Important note: If both switches are turned off the amplifier will appear not to work, as all speakers will be switched off!

32 HEADPHONES SOCKET

Accepts headphones rated between 8 ohms and 2k ohms fitted with a 1/4" stereo jack plug. If you wish to listen on headphones only, use SPI and SP2 (if necessary) to mute the speakers. The headphone socket is always active.

Power amp - Setting up

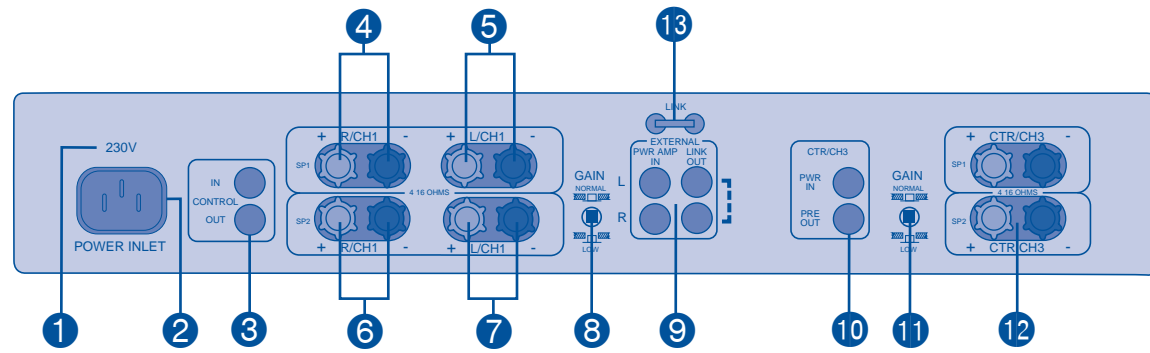

CONNECTING TO POWER, SPEAKERS, and OTHER EQUIPMENT

Follow the guidelines for the integrated amplifier in this handbook.

9 PWR AMP IN

Connect this input to the output sockets of your pre-amplifier or the PRE-AMP OUT sockets of an integrated amplifier.

13 MONO LINK

The integrated amplifier can be adapted to provide two mono loudspeaker outputs from a single input. Pull out the U-link 13 supplied and use it to connect the LINK OUT sockets together.

Utilising one power amplifier per loudspeaker will enable you to bi-amplify bi-wireable loudspeakers. This is particularly beneficial for top quality stereo installations with a separate pre-amplifier; or for the left, centre and right channel loudspeakers in a five speaker Dolby Pro Logic™ or Dolby Digital™ system.

Contact your Arcam dealer for more detailed information.

DAISY CHAIN

The power amplifier is capable of driving further power amplifiers (or any other power amplifier), to drive more speakers (e.g. those in other rooms or tri-amplified speakers etc). Connect the extra power amplifier inputs to the LINK OUT sockets on the power amplifier; left to left, right to right.

P25 REMOTE SWITCHING

By making a connection from the 'control out' socket 3 of the A22 to the 'control in' socket 3 of the P25 power amplifier you can use the A22 to control the power output of the power amplifier. If configured in this way the front panel power button of the A22 (or remote control standby button) will switch both amplifiers on or off simultaneously. This facility allows you to hide the power amplifier out of sight and still be able to control its functions.

The connecting cable required is a 3.5mm to 3.5mm jack lead (stereo or mono) and it is possible to connect several P25 power amplifiers to an integrated A22 by 'daisy chaining' from 'control out' of one into the 'control in' of the next as shown in the diagram at the bottom of the page.

THIRD CHANNEL OPTION 10, 11, 12

This option enables you to have a 5 channel amplifier when used with a suitable integrated amplifier; to create a high quality Home Cinema setup.

The third channel can be used to drive the centre speaker. For connection details see DAVE amplifier 'Setting up'. Please contact your dealer for availability of this module.

Now you have finished 'Setting up', return to the 'User Guide'.

DAISY CHAIN WIRING GUIDE

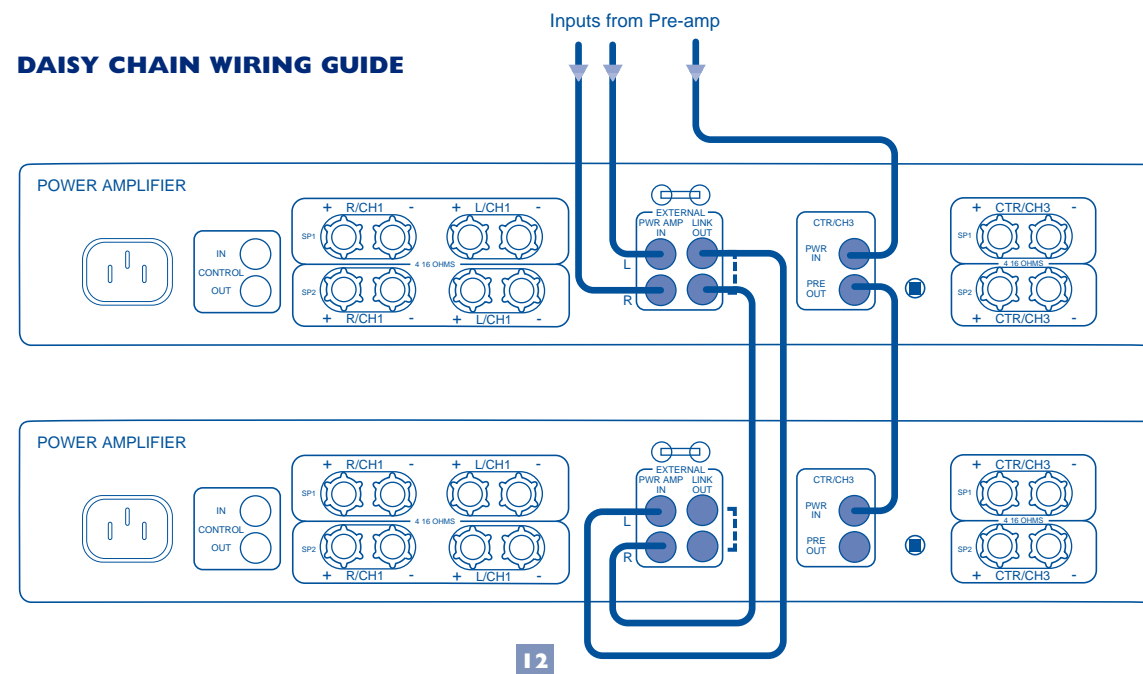

12

Amplifiers - Technical specifications

TECHNICAL SPECIFICATIONS	INTEGRATED AMPLIFIER	POWER AMPLIFIER
Output power (20Hz-20kHz at 0.5%THD)		
8ohms, both channels	100W	100W
8ohms, single channel, 1kHz	110W	110W
4ohms, single channel, 1kHz	170W	170W
Harmonic Distortion, 100W, 8 at 1kHz	0.02% typical	0.02% typical
Peak current rating	±25A	±25A
L/R Crosstalk	-80dBV at 1kHz	-
Frequency response ± 0.5dB	-	10Hz-20kHz
Input impedance	-	7.5k
Input sensitivity		740mV (Normal Gain) 1.0V (Low Gain)
INPUTS		
Line inputs:		
Sensitivity	160mV	-
Noise (CCIR) ref. rated power	-100dB	-100dB
Input impedance	10k	-
Overload margin	>30dB	-
A/V loop input (A/V mode):		
Sensitivity	680mV	-
Input impedance	7.5k	-
Power amp in:		
Sensitivity	740mV (Normal Gain) 1.0V (Low Gain)	-
Input impedance	7.5k	-
Phono board (if fitted):		
Sensitivity	2.6mV MM, 26µV MC	-
Noise (CCIR) ref. rated power	-79dB MM, -73dB MC	-
Input impedance	47k MM, 300 MC	-
Overload margin	35dB	-
OUTPUTS		
Pre-amplifier Output:		
Nominal output level	800mV	-
Maximum output level	8V	-
Output impedance	50	-
Tape/ AUX output:		
Output impedance	50	-
Headphones:		
Maximum output level into 600	8V	8V
Output impedance	100	100
Mains voltage	230V ± 12% 115V ± 12%	230V ± 12% 115V ± 12%
Power consumption(max)	800VA (8VA in standby)	800VA (8VA in standby)
Dimensions W/D/H mm.	430x380x110	430x350x110
Weight net	10.9 kg	10.6 kg
Weight packed	13.1 kg	12.5 kg
Supplied accessories	Mains lead	Mains lead
	Remote Control Handset	
	2 x AAA batteries	
E&OE		

13

DAVE amplifier - User Guide

INTRODUCTION

The DAVE (Digital Audio Video Entertainment) module, transforms the integrated amplifier into a state-of-the-art Audio Visual system. By connecting it via a power amplifier an extra 3 channels can be added, enabling 3 extra loudspeakers (5 in total). The extra dimension of truly high quality sound makes movies, sport and your favourite TV programmes a much more exciting experience. The DAVE is capable of providing a level of sound quality which will match a modern cinema. The DAVE will accept Stereo, Dolby Digital, Dolby Pro Logic, Dolby 3 Channel, DTS, and Digital Stereo signals. You are recommended to read the integrated amplifier 'User Guide' first, for an introduction to the many features of the integrated amplifier which are identical to the DAVE amplifier.

IN USE

Circled numbers in the text, e.g. 33, refer to the numbers on the pictures.

If your DAVE amplifier has not been installed for you, you should read the section entitled 'Setting up' before using the 'User Guide'.

WHAT CAN DAVE DO?

The DAVE is supplied with an Arcam learning programmable Remote Control which can operate all the components of your Audio Visual system. For full details of how the CR 9000 Remote Control works, consult the Operating Manual supplied with it.

- 33 POWER**
Switches the amplifier on.
- 34 POWER INDICATOR**
This will initially glow orange. After a few seconds, it will glow green. When the indicator glows orange, the speakers are disconnected and an internal protection circuit is activated.
- 35 DISPLAY**
When the amplifier is turned on the display shows:



CHOOSING YOUR ENTERTAINMENT

Make sure that the CR9000 has its batteries installed. Make sure it is in AUDIO mode by pressing the 'AUD' button at the top of the Remote Control. AUDIO will show in the display. Make sure that the source equipment (eg DVD player, Satellite receiver etc.) is turned on.

USING THE REMOTE CONTROL

Press the appropriate button showing the abbreviated name of the source entertainment you want to listen to, eg CD, TUNER etc.



or...USING THE FRONT PANEL

Press the appropriate button showing the abbreviated name of the source entertainment you want to listen to, eg CD, TUNER etc. The display will show this sequence.



The green LED light on the front panel (under the source you have chosen) will light up.

The source equipment may be either digital or analogue. The DAVE will automatically select the best type of signal from each specific source and programme being played. You can use the front panel 'MODE' button 23 (press it once, twice or more) or the MODE (up/down) buttons on the Remote Control, to override this function and manually select the decode mode you wish to listen to.

CHANGING THE VOLUME

USING THE REMOTE CONTROL

Press the VOL buttons showing (up/down) OR (up/down) on the remote control. The volume you set will be shown in the display on the front panel.

or...USING THE FRONT PANEL

Adjust the volume control knob 27. The volume you set will be shown in the display.

STANDBY

You can leave your DAVE turned on when temporarily not in use by pressing the POWER button on the remote control. You will see the word 'Standby' in the front panel display for a few seconds. Then the power indicator light 34 on the front panel, will turn red. To return to full power, ready for use, press the POWER button again. The power indicator light 34 will initially glow orange, then turn to green. The unit is ready for use.

SPEAKER SET UP

There are several adjustments which can be made to your speaker trims if you are listening from a different position in the room. It is possible to adjust the gain of the centre and rear channels by +/- 12dB using the remote control handset.

A pink noise generator is available which will cycle through the available speakers (at 2 second intervals) making it possible to adjust trim levels and confirm good connections between the speakers and the amplifiers. This can be accessed at any time by pressing the TEST [ALT] button on the remote.

It can also be accessed in setup mode (see the section of this handbook called 'Setting up')

You should adjust the trims so that all speakers produce the same volume at your normal listening position. Adjust speaker trims whilst the noise is being generated by pressing the TRIM buttons (up/down) and (up/down) for the centre speaker and the REAR buttons (up/down) and (up/down) for the rear speakers. If you adjust a speaker trim then the noise will stay on the channel being adjusted until shortly after you have finished making the adjustment. See also 'Using the Menus' in the 'Setting up' section of this handbook.

NIGHT TIME LISTENING

This reduces the overall loudness of the program being listened to whilst still making it easy to hear the voices and effects. To select press NIGHT on the remote handset. 'Late Night mode On' will be displayed for a few seconds. To deselect press NIGHT again.

DAVE amplifier - Setting up

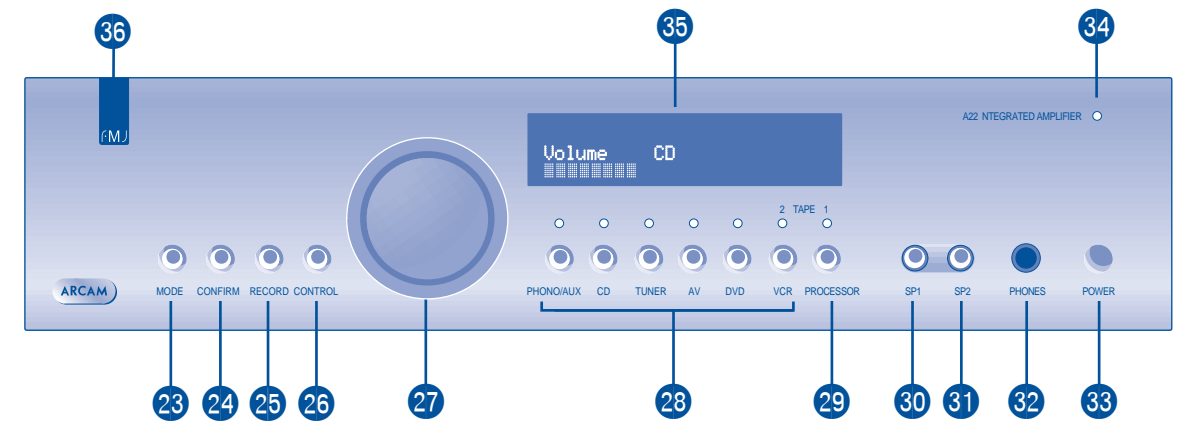

DAVE 10 PARTS CHECK

Your DAVE amplifier is supplied with:

REMOTE HANDSET

A CR 9000 programmable and learning Remote Control. A separate Operating Manual is supplied with this Remote Control.

CREATING YOUR 5 CHANNEL SET UP

To create a 5 speaker set up you should first connect your DAVE amplifier and power amplifiers to the five speakers as shown above. In this setup the integrated amplifier is used to power your front left and right speakers and the power amplifier is used to power the centre and the rear two speakers.

DAVE AMPLIFIER WIRING GUIDE

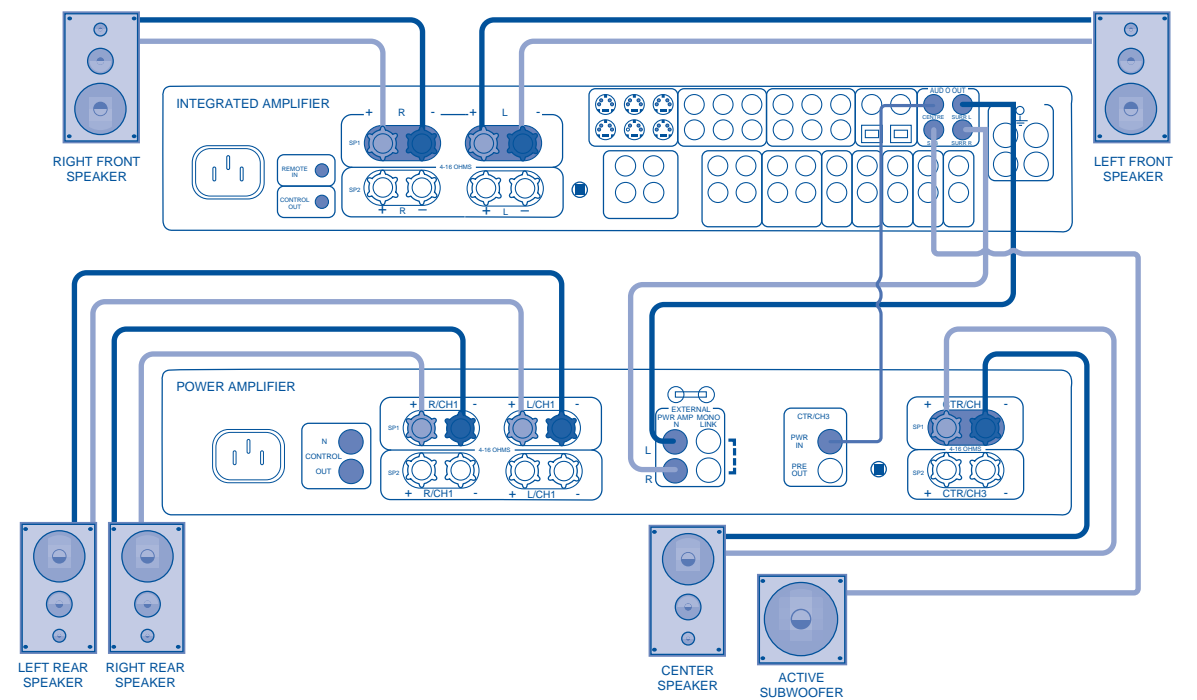

CONNECTING TO OTHER EQUIPMENT

There are two different types of video signals. Some equipment is manufactured to one type, some to the other. One is called either 'SVideo' or SVHS (which usually has a higher quality picture), the other is 'Composite video'.

The DAVE does not convert one to the other. You can connect equipment sending both types of signal to your DAVE at the same time. However, you shouldn't connect two similar pieces of equipment (e.g. an 'SVideo' Laser disc and a 'Composite video' Laser disc at the same time).

If you are connecting some 'SVideo', and some 'Composite video' equipment you must connect your TV (monitor) to both the 'SVHS' and the 'COMPOSITE VIDEO' MON OUT (monitor out) sockets.

For optimum video performance always use 75 ohm cables designed for video use.

When watching a videotape that has a copy prohibit signal, eg Macrovision™, the On Screen Display (OSD) may sometimes wobble or move slightly. This is normal and does not indicate a problem with the unit.

COMPOSITE VIDEO CONNECTIONS

See the diagrams below and opposite.

- 41 VCR OUT**
Connect this output socket to the video input socket of your video recorder.
- 42 VCR IN**
Connect this input socket to the composite video output socket of your video recorder.
- 43 AUX IN**
Connect this input socket to the composite video output socket of your source.

- 52 AV IN**
Connect this input socket to the composite video output socket of your source.
- 53 DVD IN**
Connect this input socket to the composite video output socket of your DVD player.
- 54 MON OUT (MONITOR OUT)**
Connect this output socket to the composite video input of your TV or monitor. You will probably need a RCA phono to phono (or phono to SCART in Europe) video cable to do this.

COMPONENT VIDEO CONNECTIONS

Note: these sockets are not normally found on European equipment.

- 40 COMPONENT VIDEO IN**
Connect these input sockets to the component video output sockets of your DVD player.
- 55 COMPONENT VIDEO OUT**
Connect these output sockets to the component video input sockets of your TV or monitor.

DAVE AMPLIFIER COMPOSITE VIDEO WIRING GUIDE

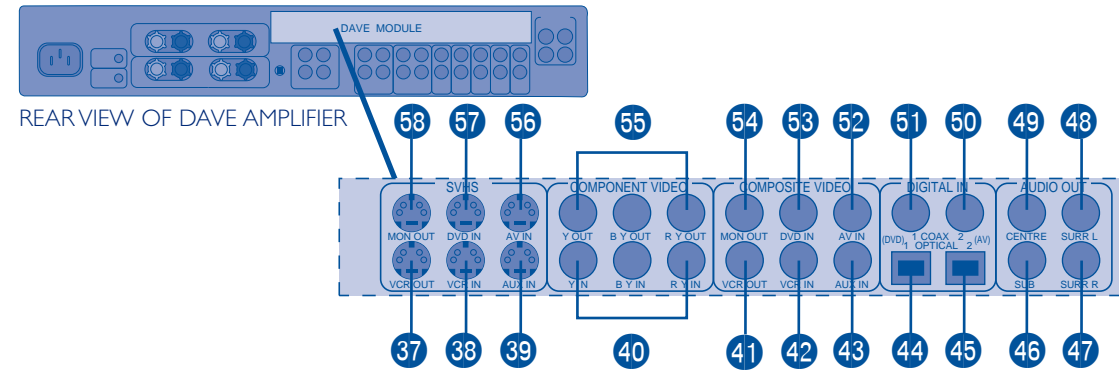
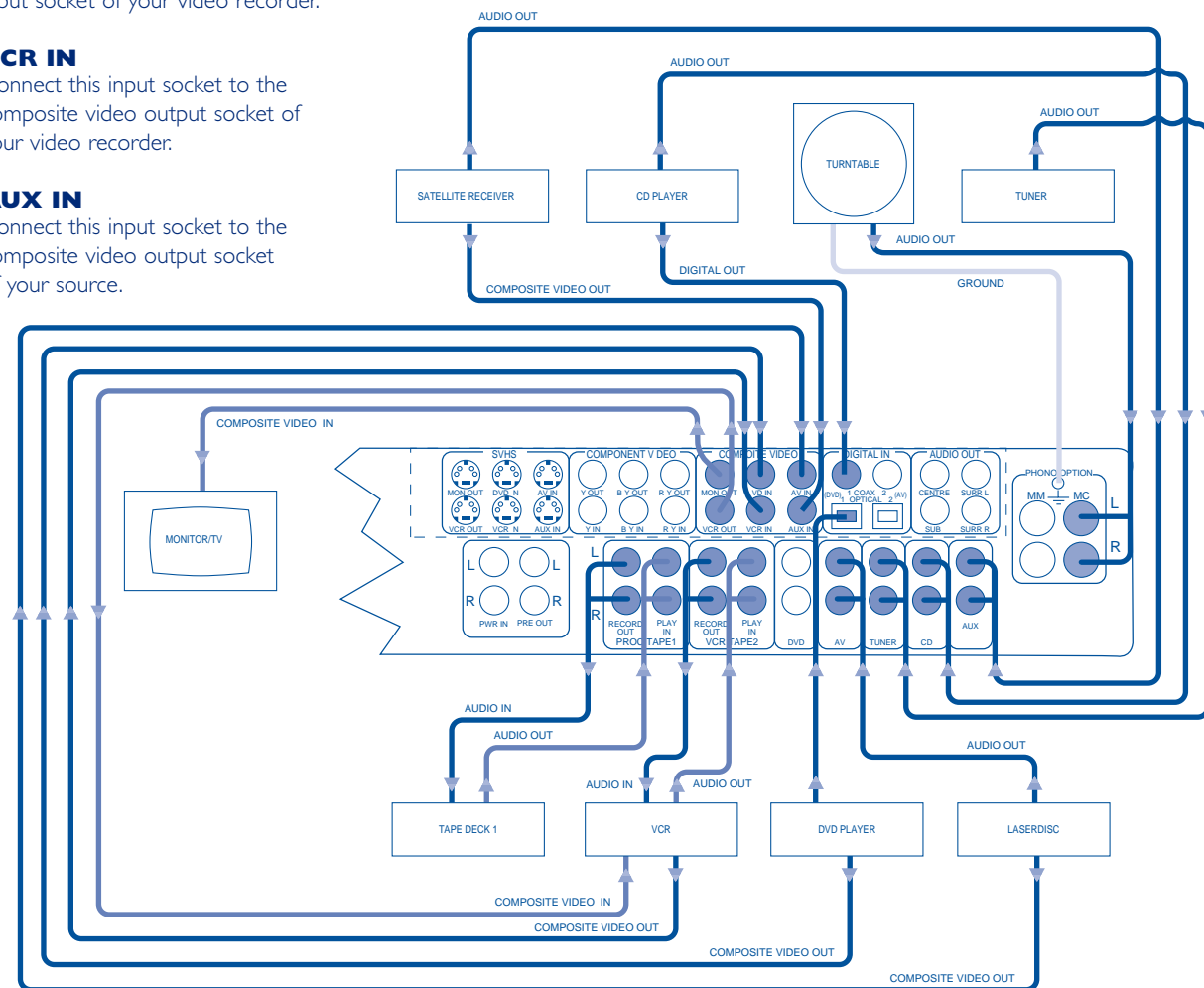

S VIDEO CONNECTIONS

See the diagrams above and opposite.

- 37 VCR OUT**
Connect this output socket to the video input socket of your video recorder if your VCR is an SVideo model.
- 38 VCR IN**
Connect this input socket to the SVideo output socket of your video recorder if your VCR is an SVideo model.
- 39 AUX IN**
Connect this input socket to the SVideo output socket of your source.
- 56 AV IN**
Connect this input to the SVideo output socket of your source.
- 57 DVD IN**
Connect this input socket to the SVideo output socket of your DVD player.
- 58 MON OUT (MONITOR OUT)**
Connect this output socket to the SVideo input of your TV or monitor.

DIGITAL INPUTS

- 44, 45 OPTICAL 1, OPTICAL 2**
Connect these input sockets to the optical digital output sockets of your DVD player, CD player, etc.
 - 51, 50 COAX 1, COAX 2**
Connect these input sockets to the coaxial digital output sockets of your DVD player, CD player, etc.
- Each of these 4 digital inputs can be individually allocated to one of these inputs: DVD, AV, AUX, CD, TUNER or VCR. This is done in the digital input setup page in the setup menu.
- 46 SUB (SUBWOOFER PRE-AMP OUT)**
Connect this output socket to the input socket of your active subwoofer, if you have one.
 - 47 SURR. R (SURROUND RIGHT PRE-AMP OUT)**
Connect this output socket to the right hand 'power amp in' socket of the amplifier connected to your surround (rear) speakers.
 - 48 SURR. L (SURROUND LEFT PRE-AMP OUT)**
Connect this output socket to the left hand 'power amp in' socket of the amplifier connected to your surround (rear) speakers.
 - 49 CENTRE (PRE-AMP OUT)**
Connect this output socket to the centre 'power amp in' socket of the amplifier connected to your centre speaker.

DAVE AMPLIFIER S VIDEO WIRING GUIDE

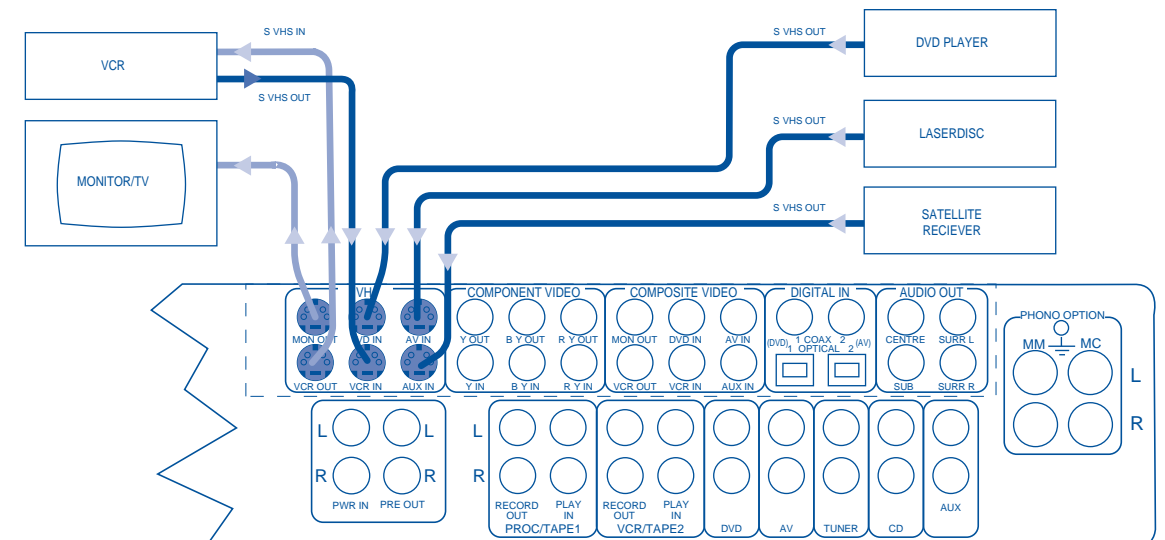

GETTING READY FOR USE

- 33 POWER**
Switches the amplifier on.
- 34 POWER INDICATOR**
This will initially glow orange. After a few seconds, it will glow green. When the indicator glows orange, the speakers are disconnected and an internal protection circuit is activated.
- 35 DISPLAY**
When the amplifier is turned on the display shows:



Before using your DAVE, you must set certain parameters for it on

TO ENTER SET UP MODE

the menus in 'Set up mode'. You can enter this mode using either the Remote Control or the front panel.

USING THE REMOTE CONTROL

The CR9000 must be in AUDIO mode to control the unit.

Press **AUD** to enter AUDIO mode.

Press **FAV** followed within 2 seconds by **MENU**.

You will see....



or...USING THE FRONT PANEL

Hold down the MODE button and whilst still holding it down press the CONFIRM button. You will see 'Misc <PAGE>'.

Either method will bring up a menu on the On Screen Display (OSD) on the TV monitor connected to your DAVE module. At the same time, the same title or selected line from the menu will show in the display on the front panel.

USING THE MENUS

There are 5 menus, each has up to 7 options. The selected menu will be appear on your 'On Screen Display' on your TV monitor. The selected line of the menu will also be displayed on the front panel display of the DAVE.

Each of the following sections starts with a picture showing what you will see as you move through the menus.

USING THE REMOTE CONTROL

Use **▲** [PAUSE] and **▼** [STOP] buttons to go up/down the menu, **◀** [REW] and **▶** [FF] buttons to alter the selection on the highlighted line, and to change menu pages when the menu heading is highlighted.

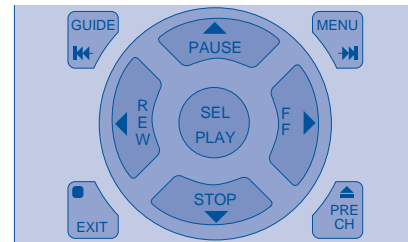

USING THE FRONT PANEL

When 'Misc <PAGE>' is showing move through the 5 menu headings using the VOLUME control. To cycle through the items on a menu, press the CONTROL button one, two, three or more times. To select a choice rotate the volume control one click at a time to cycle through the available choices. After you have cycled through each of the items on a menu, return to <PAGE> using the CONTROL button, then you can then use the VOLUME control to move onto other menus.

Menu page 1/5 - Miscellaneous

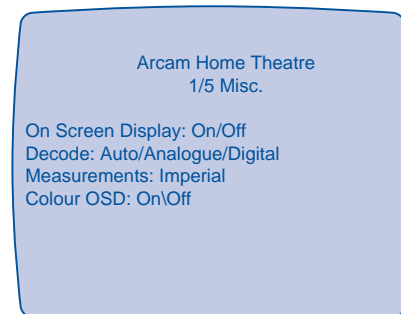

ON SCREEN DISPLAY ON/OFF

Default is on. If you choose 'off' the on screen display (OSD) will go off once you have saved the settings and will not show when you adjust volume, change inputs, etc, unless you go back to the setup menu screen again.

N.B.

To turn the OSD on again you have to go back into setup menu and reselect 'On Screen Display On'.

DECODE MODE

Auto - Automatically selects the digital source if present.
Analogue - Allows selection of analogue sources only.
Digital - Allows selection of digital sources only.
Auto mode is recommended.

MEASUREMENTS - IMPERIAL/METRIC

Choose your preferred unit of measure for the distance of speakers from your sitting position adjusted on menu page 3/5 (delay setup).

COLOUR OSD

With OSD on the background screen for the OSD on the TV will be blue. With OSD off the background will be grey. This latter mode may be better in some countries that use non mainstream video standards.

Menu page 2/5 - Speaker Sizes

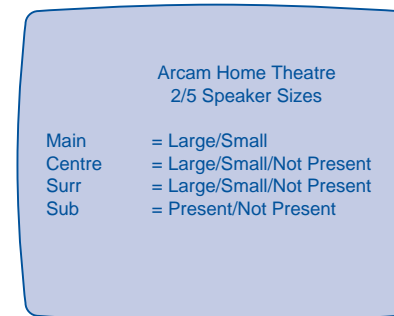

Choose between large, small or not present. Where applicable this information is used in Dolby Digital decoding to redirect bass signals to speakers that can handle them.

If you choose 'Not present' for a speaker then you will not be given the option to set delay times for these speakers on menu page 3/5.

Menu page 3/5 - Delay Setup

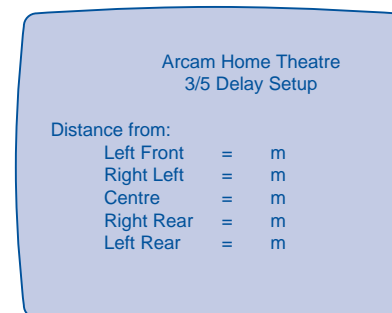

Select each speaker in turn and then enter the distance from the speaker to your normal sitting position. This range is adjustable from 0-25 feet in 1 foot steps (0-7m in 0.3m steps).

DELAYS

Your DAVE automatically adjusts the channel delay times to achieve 'coincident arrival' of sound from the speakers when you have entered the distance from your listening position to each of your speakers.

Menu page 4/5 - Speaker Trims



TEST TONE ON/OFF

Turn the test noise on to cycle through the speakers and adjust the relative levels of them. The noise will continue to cycle until turned off. Use the trim to adjust for an equal level of noise from each speaker at the listening position.

The trim levels are relative to the volume of the left and right front speakers so if you increase/ decrease the volume using the volume up **▲** or down **▼** buttons on the remote or the front panel volume knob, the centre, rear and subwoofer levels will also change accordingly.

To adjust the level of the centre, rear and sub (AV and stereo) use the **◀** [REW] button to move the sound left and **▶** [FF] button to move the sound right.

The test noise will stay on the selected speaker whilst you are making adjustments and then go onto the next speaker after a few seconds.

Subwoofer

There is only one subwoofer pre-amp out on the DAVE but it is possible to have one volume setting for home cinema use (AV) and another for when listening in stereo mode.

To adjust the sub (AV and stereo) use the **◀** [REW] button to move the sound left and **▶** [FF] button to move the sound right. You can turn the stereo sub output off by turning the level fully down until OFF is shown on the display.

See also 'Speaker setup' in the 'User Guide' section of this DAVE handbook.

Menu page 5/5 - Digital Input Setup

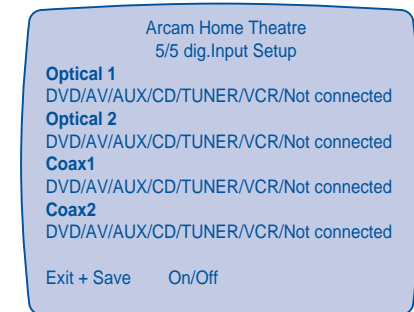

The DAVE module has 4 digital inputs (2 x optical, 2 x coaxial). Each of these can be allocated to one of 6 inputs DVD/AV/AUX/CD/TUNER/VCR or Not Connected. Each digital input can only be allocated to one input e.g. if you chose Optical 1 to be for DVD the choices for Optical 2 are now only AV/AUX/CD/TUNER/VCR or not connected, etc. If you wish to re-allocate DVD to another input you must first change Optical 1 to another source, e.g. AUX, before you can allocate DVD to a different input.

TO EXIT MENUS AND SAVE SETTINGS

USING THE REMOTE CONTROL

Press the **MENU** button any time.

USING THE FRONT PANEL CONTROLS

Press the front panel CONFIRM button at anytime from any menu. Both the OSD and front panel display will then show 'Settings Saved' for a couple of seconds to confirm this.

Your unit now has the settings stored in memory as 'Favourite Settings'. You can choose to trim the centre and surround levels to suit a particular movie, then restore the stored settings at any time by pressing FAV RESTORE on the remote.

Now you have finished 'Setting up', return to the 'User Guide'.

DAVE amplifier - Advanced features

MODE SELECTION

The following modes will be available: Stereo, Dolby Digital, Dolby Pro Logic, Dolby 3 Channel, DTS, Digital Stereo.

Note:
Some modes may be disabled dependant on the actual input signal.

Modes can be selected by use of the front panel MODE button or the MODE   buttons on the remote handset.

The modes that are selectable are dependant on the actual source material being played. These are shown below:

PCM DIGITAL INPUT(CD SIGNAL): Digital stereo, Dolby Pro Logic Digital, Dolby 3 Channel (if no rears are selected).

DOLBY 2 CHANNEL: Dolby Digital Stereo, Dolby Digital Pro Logic, Dolby Digital 3 channel (if no rear speakers are selected)

DOLBY MULTI CHANNEL: Dolby Digital stereo mx (mix down), Dolby Digital XXX eg 3/2.1

DTS 2 CHANNEL: DTS Digital Stereo

DTS MULTI CHANNEL: DTS Digital Stereo Mx, DTS Digital XXX

ANALOGUE: Stereo analogue, Dolby Pro Logic - analogue, Dolby 3 Channel (if no rear speakers are selected).

MULTICHANNEL MODES

Source material, particularly DVDs, will vary from disc to disc in the number of surround channels encoded. Frequently, you may find only stereo has been encoded, particularly on older movies.

Below are some of the more commonly available formats.

Source material signal type	Displayed as	Alternative description
Mono	mono	-
Left+Right	stereo	-
Left+Right Pro Logic encoded	Surround	'Digital Pro Logic'
Centre+Left+Right+Surround (mono)	Digital 3/1/0	'Digital 4.0'
Centre+Left+Right+Surround L, R	Digital 3/2/0	'Digital 5.0'
Centre+Left+Right+Surround L, R & LFE	Digital 3/2/1	'Digital 5.1'

LISTENING ON HEADPHONES

If you wish to listen to a source that is not a 2 channel stereo source you MUST change the mode to a stereo mode in order to hear all of the sound correctly on the headphones. For example if you are listening to a DVD player in 5.1 channel mode you would have to set the mode to Dolby Digital Stereo mixdown when listening on headphones. If you don't you will not be able to hear any of the main dialogue signals on your headphones because this is a centre channel signal.

VENTILATION

Adequate ventilation MUST be provided for the DAVE amplifier, and it is strongly recommended that it is not stacked with other products, particularly additional power amplification. The DAVE surround decoding circuitry requires a temperature controlled environment in which to function correctly. If the internal temperature of the unit reaches a certain point, a cooling fan will begin operating to cool the circuitry. You may hear this as a very quiet whirring sound coming from the amplifier. This is normal. If the temperature continues to rise the amplifier may shut itself down to allow it to cool. If this happens the unit will switch into standby mode and 'Fault Condition Protection' will be shown on the display. When the unit has cooled down sufficiently the unit will automatically switch out of standby again.

In addition, fan cooling is also provided for the two main output channels. This cooling is only activated above a certain temperature, and when there is a signal present, so any fan noise will be masked as far as possible, by the loudspeaker output.

TAPE RECORDING

It is only possible to record from an analogue source. You cannot record from any digital source. If you wish to record from a CD player connected to one of the digital inputs you will have to make a connection from the analogue outputs of the CD player directly to your recorder or to the analogue CD inputs of the Alpha 10. In the latter case you can then record the CD signal by pressing the front panel RECORD button followed by the CD input button.

To record from a laser disc player connected to the AV analogue inputs of the amplifier first press the RECORD selector followed by the AV button. This will route the audio signals of the Laser Disc to the VCR Audio Record Out sockets and the video signal to the composite or S Video VCR OUT socket (S Video, Composite video). Note: you may not be able to record the video signal if it contains Macrovision copy prohibit signals.

LISTENING TO AN ANALOGUE OUTPUT

The amplifier will automatically switch to the best source signal when an input is selected if DECODE mode has been set to 'AUTO'. For example if you have a CD player connected to the digital input and also an analogue connection to the CD inputs the unit will default to the digital signal when CD is selected. To force the unit to the analogue input press and hold the CD button until Analogue is shown on the OSD or front panel display. This will take about 4-5 seconds. If you press the CD button again it will reselect the CD digital input signal.

DAVE amplifier - Remote Control Handset

The CR 9000 Programmable and learning Remote Control Handset is supplied with the DAVE amplifier.

This Remote Control Handset can be programmed to send messages to other devices in your home entertainment system. The Remote Control therefore has a universal numbering system to cross reference a button to a function. This is required as the words printed on the Remote Control and the programmed functions may not be the same.

Refer to the CR 9000 Operating Manual for full instructions.

The adjacent diagram will help you to access the functions of other equipment using the universal reference numbers in the Operating Manual supplied.

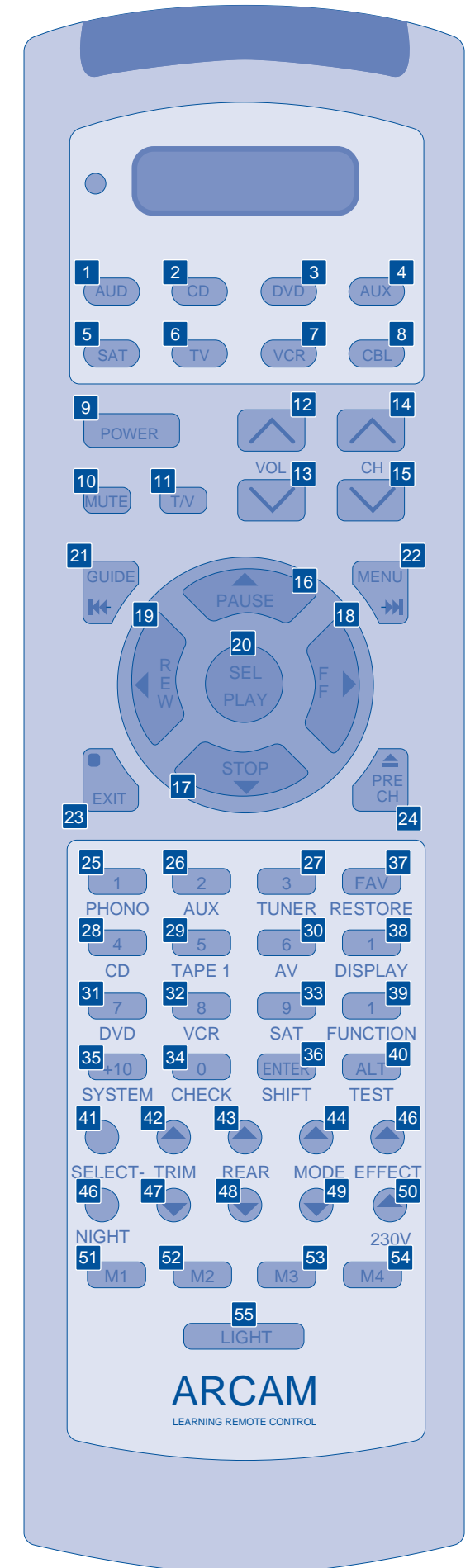

INTRODUCTION

The MARC (Multi-Area-Remote-Control) amplifier is a module fitted inside an Arcam integrated amplifier. It gives access to and use of, the source components (e.g. Tuner; CD player etc.) connected to the integrated amplifier in other locations within a house. For instance one room can be listening to a CD while another room can be listening to a radio broadcast. An extra amplifier (such as the P25) is required for each of the other locations. Each location in the house is referred to as a 'zone'. The room where the integrated amplifier is located is called zone 1. The other rooms are zones 2-5. You are recommended to read the integrated amplifier 'User Guide' first, for an introduction to the many features of the the integrated amplifier which are identical to the MARC amplifier.

HOW MARC IS CONTROLLED

Your MARC can be controlled in two ways.

1. MARC is normally controlled from each zone by use of an infra-red remote handset, or wallmounted keypad, depending on your installation. Remember that MARC and the associated equipment must be on, or in standby condition for the system to work! If the system is in standby, a power on command will normally be required before use.

2. MARC will also allow you to adjust each zone from the front panel of the amplifier if required.

If you want to make **temporary** changes to zones 2-5, use the source Balance and Volume controls shown in this 'User Guide' section. These adjustments can either be set in zone 1, using the MARC amplifier, or using the controls on a Keypad or a Remote Control within each of the zones.

If you want to make more **permanent** changes and over-ride changes in the zones (2-5) you should refer to the section entitled Advanced Features.

IN USE

Circled numbers in the text, e.g. 23, refer to the numbers on the pictures.

POWER ON

The POWER button must be ON for the MARC to be operated from zone 1 or other zones.

33 POWER
Switches the amplifier on.

34 POWER INDICATOR
This will initially glow orange. After a few seconds, it will glow green. When the indicator glows orange, the speakers are disconnected and an internal protection circuit is activated. When the unit is in standby mode the light will glow red.

35 DISPLAY
When the amplifier is turned on the display shows:



Then...



This is called the idle mode. The selected source (in this case Tuner) is shown in the display.

STANDBY

A command is required to bring the system out of standby condition. This is done by using the 'STANDBY' or 'POWER' button on the Remote Control or keypad.

Note that there will be a delay of at least 6, possibly 15 seconds before the system responds with music.

Be patient, otherwise repeated operation of the power command could lead to confusion.

There are three levels of standby in the MARC system.

System standby

Putting the MARC into system standby prevents the distribution of music to all zones. The state of system standby is changed by using the standby/power button on the remote control in zone 1, or by pressing and holding for four seconds, standby/power, in zones 2-5. Note that your system may be configured so that this command is blocked from selected zones.

Local standby - Zones 2-5

To bring one zone out of standby, press standby/power on the handset or keypad in that zone. The zone will then power up in its default condition.

To put the zone into standby, use a short press on the standby/power key.

Mute

Using a mute command in any zone, e.g. to answer the phone, temporarily mutes that zone. On a second mute or change of volume command, the zone continues in the mode before muting was used.

Troubleshooting

If no sound is heard, ensure all amplifiers are powered on and all source components are operating.

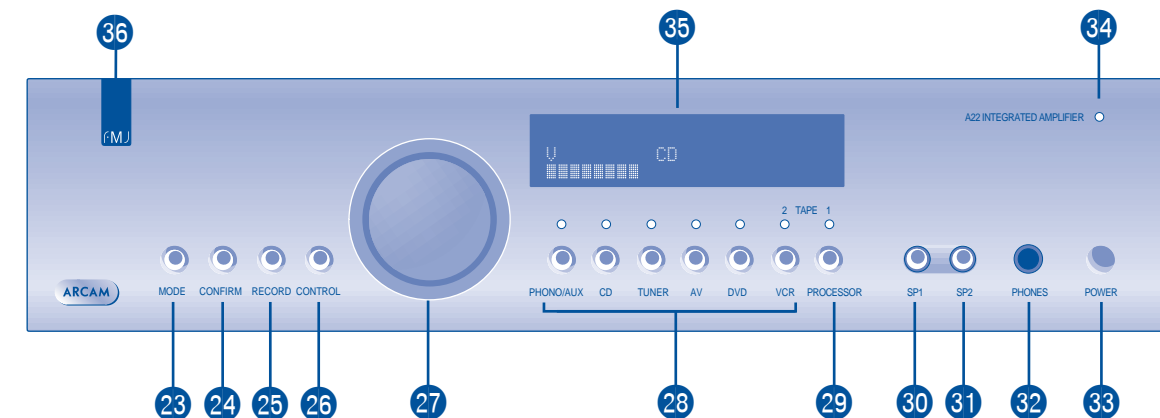

ZONE CONTROL

MAKING ZONE CHANGES

Using the front panel of the integrated amplifier.

To move between zones

Press MODE 23 once, or several times, to scroll through the zones. Once the desired zone is showing in the top right hand corner of the display, like this....



...you can make changes to that zone.

When no zone number is shown you are in zone 1. If you do not press another button within 8 seconds of pressing MODE, the display will go back to zone 1 (idle position).

Changing the source in zones 2-5

Press MODE 23 once, or several times, to scroll through the zones. Choose the source you wish to select in that zone by pressing the appropriate button 28. The green light (LED) above the source you have chosen will light up.

When you move on to the next zone, or when the display returns to idle mode after 8 seconds your selection will be saved. When you return to the zone you have changed, the green light (LED) will show above the source you have saved.

Changing the volume

Press MODE 23 once, or several times, to scroll through the zones. Adjust the VOLUME control knob 27.

The volume you set will be shown in the display. When you move on to the next zone, or when the display returns to idle mode after 8 seconds your selection will be saved. When you return to the zone you have changed, the volume bar graph will show the volume you have saved.

Changing the balance

Press MODE 23 once, or several times, to scroll through the zones. Press CONTROL 26 once to select balance. Adjust the balance by rotating the VOLUME control knob 27. The balance you set will be shown in the display.

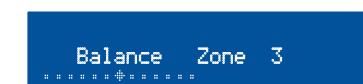

When you move on to the next zone, or when the display returns to idle mode after 8 seconds your selection will be saved. When you return to the zone you have changed, the display will show the balance you have saved.

PARTY MODE

If you want the same entertainment source in each room, use the Party Mode. Press CONTROL 26 twice to show whether Party Mode is on or off. It can be switched On or Off by rotating the VOLUME control 27. When Party Mode is on, all zones are locked to the same source. You may select the source by pressing 28. However, you can adjust the volume within each different zone and use the MUTE control to cut the sound.

Party Mode is automatically switched off when the power button is switched off, or the MARC is put into system standby.

ACTIVITY MONITOR

Press the CONTROL 26 three times to show whether activity monitor is on or off. Turn the volume control knob 27 to switch between on and off. If OFF shows in the display the activity in zones 2-5 cannot be observed on the display. If ON shows you can monitor which source and volume changes are being made in each zone. If disallowed commands are received from a zone, 'DENIED' will show in the display.

MARC amplifier - Advanced features

CAUTION

If you intend to change any of the settings described on this page, please read the following notes thoroughly to familiarise yourself with the process before amending the settings.

To access the zone control menus....

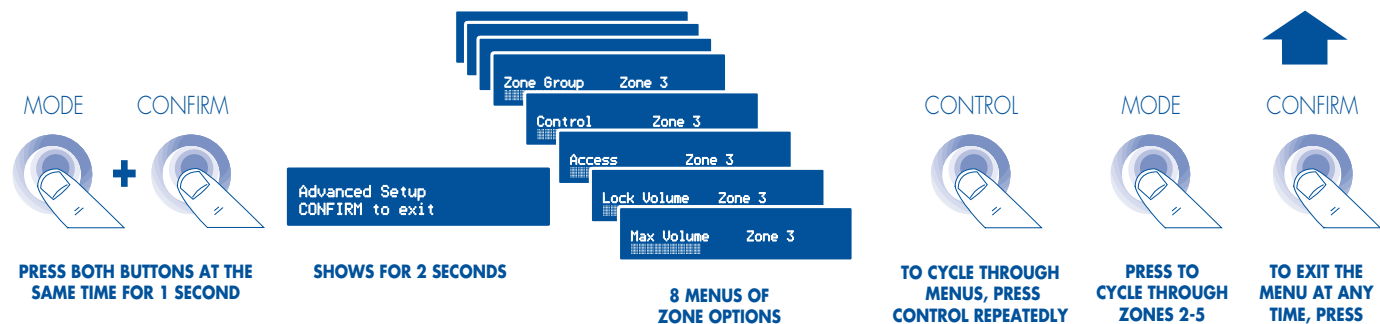

SET UP MENUS

Maximum Volume

This control restricts the overall volume level in each zone to a pre-set maximum. This takes priority over any other setting. Once you have accessed the zone you wish to change, turn the volume control knob. The volume bar graph will show the maximum volume level in the selected zone. Press CONTROL to move further through the menus, or MODE to stay on this menu, but move to a different zone.

Lock Volume

When on, this control locks the current volume in each zone so that it cannot be changed. The MUTE control will still work within each zone. Turn the VOLUME control knob to change from YES to NO or vice versa. Press CONTROL to move further through the menus, or MODE to stay on this menu, but move to a different zone.

Access

This selects which entertainment source can be played or accessed in each zone. Press the source buttons **28** to select one or several entertainment sources you want the zone to have access to. The green LED light above the button will show the selections you have made.

Press CONTROL to move further through the menus, or MODE to stay on this menu, but move to a different zone.

Control

This selects which entertainment source can be controlled in each zone. Press the source buttons **28** to select one, or several entertainment sources you want the zone to control. The green LED light above the button will show the selections you have made. Press CONTROL to move further through the menus, or MODE to stay on this menu, but move to a different zone.

Zone group

Zone grouping allows you to lock several zones to the same source - if you change the source in one of these zones, all zones in the group change as well. The volume controls are independent. A typical application would be for bedroom with en-suite bathroom.

Returning to factory settings

If you have a system setting problem and you want to clear all settings back to factory defaults, press and hold both CD and VCR buttons on the amplifier for 5 seconds. The display will show the power on screen 'Arcam Multiroom Amplifier' to confirm that your settings have been cleared.

To put a zone in a group, use the VOLUME control knob **27**. Options are 'None', 'Group A' or 'Group B'.

Power On source

When the unit is powered up, or a zone comes out of standby a power on source is selected.

Use the source buttons **28** to set the power on source for a given zone. Pressing any source button twice selects 'Previous' i.e. the source which was active before standby or power down.

Power On volume

When the unit is powered up, or a zone comes out of standby a power on source is selected.

This can be changed as follows:

Use the VOLUME control knob **27** to set the power on volume. Turning the volume down below minimum sets it to 'Previous'. Note that if Lock Volume (see above) has been set, then the power on volume always shows 'Previous'.

Standby rights

As shipped from the factory, the entire system can be placed into standby by pressing and holding the standby/power button in a zone. This menu allows you to block this operation. Note that all zones are always able to bring the system out of standby.

Use the volume control knob **27** to change the standby rights. Options are 'Local only' or 'Local + all off'.

To exit the set up menus press CONFIRM at any time.

Safety Guidelines

SAFETY IN USE

SAFETY STANDARD

This product has been designed to meet the EN60065 international electrical safety standard.

SAFETY INSTRUCTIONS

This product was designed and manufactured to meet strict quality and safety standards. There are, however, some installation and operation precautions of which you should be particularly aware:

- 1. Read Instructions** All the safety and operating instructions should be read before the appliance is operated.
- 2. Retain Instructions** The safety and operating instructions should be retained for future reference.
- 3. Heed Warnings** All warnings on the appliance and in this handbook should be adhered to.
- 4. Follow Instructions** All operating and use instructions should be followed.
- 5. Water and Moisture** The appliance should not be used near water - for example near a bathtub, washbowl, kitchen sink, laundry tub, in a wet basement or near a swimming pool, etc.
- 6. Racks and Stands** The appliance should be used only with a rack or stand that is recommended for use with audio equipment. If the equipment is on a portable rack it should be moved with care. Quick stops, excessive force, and uneven surfaces may cause the combination to overturn.
- 7. Ventilation** The appliance should be situated so that its location or position does not interfere with its proper ventilation. For example, the appliance should not be situated on a bed, sofa, rug or similar surface that may block the ventilation openings or placed in a built-in installation, such as a bookcase or cabinet that may impede the flow of air through the ventilation openings. We recommend a minimum distance of 50mm (2 inches) around the sides and top of the apparatus to provide adequate ventilation.

- 8. Heat** The appliance should be situated away from naked flames and equipment, heat such as radiators, stoves or other appliances (including other amplifiers) that produce heat.
- 9. Power Sources** The appliance should be connected to a power supply only of the type described in the operating instructions or as marked on the appliance.

- 10. Grounding** Precautions should be taken so that the grounding means of the appliance is not defeated.
- 11. Power-Cord Protection** Power supply cords should be routed so that they are not likely to be walked on or pinched by items placed upon or against them, paying particular attention to cords and plugs, and the point where they exit from the appliance.

- 12. Cleaning** Unplug the unit from the mains supply before cleaning. The appliance should normally only require a wipe over with a clean, dry, lint-free cloth. If it is heavily soiled then a cloth slightly dampened with a water/washing up liquid solution may be used. Dry the unit afterwards with a dry cloth.

- 13. Power Lines** An outdoor antenna/ aerial should be located away from power lines.

- 14. Non-use Periods** If the unit has a standby function, a small amount of current will continue to flow into the equipment in this mode. The power cord of the appliance should be unplugged from the outlet when left unused for a long period of time.

- 15. Object and Liquid Entry** Care should be taken so that objects do not fall and liquids are not spilled into the enclosure through any openings. Objects filled with liquids, such as vases, should not be placed on the equipment.

- 16. Abnormal Smell** If an abnormal smell or smoke is detected from the appliance, immediately turn the power off and unplug the unit from the wall outlet. Contact your dealer immediately.
- 17. Damage Requiring Service** The appliance should be serviced by qualified service personnel when:
 - A. The power-supply cord or the plug has been damaged or;
 - B. Objects have fallen, or liquid has spilled into the appliance or;
 - C. The appliance has been exposed to rain or;
 - D. The appliance does not appear to operate normally or exhibits a marked change in performance or;
 - E. The appliance has been dropped or the enclosure damaged.
- 18. Servicing** You should not attempt to service the appliance beyond that described in this handbook. All other servicing should be referred to qualified service personnel.
- 19. Climate** The appliance has been designed for use in moderate climates. This appliance is normally supplied with a moulded mains plug already fitted to the lead. If for any reason the plug needs to be removed, it must be disposed of immediately and securely, as it is a potential shock hazard when inserted into a mains socket.

- 20. Servicing** You should not attempt to service the appliance beyond that described in this handbook. All other servicing should be referred to qualified service personnel.

ELECTRICAL CONNECTIONS

This appliance is normally supplied with a moulded mains plug already fitted to the lead. If for any reason the plug needs to be removed, it must be disposed of immediately and securely, as it is a potential shock hazard when inserted into a mains socket.

Warning: This appliance must be earthed.

If the plug is removed then the remaining lead must be rewired as follows:

The blue wire must be connected to the terminal which is coloured blue or marked with the letter N.

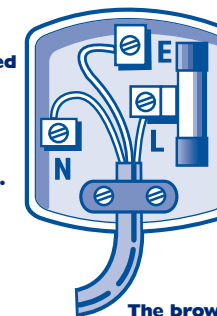

The green and yellow wire must be connected to the terminal which is coloured green and yellow, or marked with the letter E or the safety earth symbol.

The brown wire must be connected to the terminal which is coloured brown or marked with the letter L.

When replacing the fuse in the supplied moulded mains plug, the integral fuse holder/cover must always be refitted. Use a 5 amp fuse.

Guarantee

WORLDWIDE GUARANTEE

This entitles you to have the unit repaired free of charge, during the first two years after purchase, at any authorised Arcam distributor provided that it was originally purchased from an authorised ARCAM dealer or distributor. The manufacturer can accept no responsibility for defects arising from accident, misuse, abuse, wear and tear, neglect or through unauthorised adjustment and/or repair; neither can they accept responsibility for damage or loss occurring during transit to or from the person claiming under the guaranteed.

The warranty covers:

Parts and labour costs for two years from the purchase date. After two years you must pay for both parts and labour costs. The warranty does not cover transportation costs at any time.

CLAIMS UNDER GUARANTEE

This equipment should be packed in the original packing and returned to the dealer from whom it was purchased, or failing this, directly to the Arcam distributor in the country of residence. It should be sent carriage prepaid by a reputable carrier - NOT by post. No responsibility can be accepted for the unit whilst in transit to the dealer or distributor and customers are therefore advised to insure the unit against loss or damage whilst in transit.

For further details contact Arcam at:

ARCAM Customer Support Department, Pembroke Avenue,
Denny Industrial Centre, Waterbeach,
Cambridge, CB5 9PB, England.
Telephone: (01223) 203203 Fax: (01223) 863384
e-mail: support@arcam.co.uk

PROBLEMS?

If your dealer is unable to answer any query regarding this or any other Arcam product please contact Arcam Customer Support on +44 (0)1223 203203 or write to us at the above address and we will do our best to help you.